

TRANSFORMERS ANIMATED

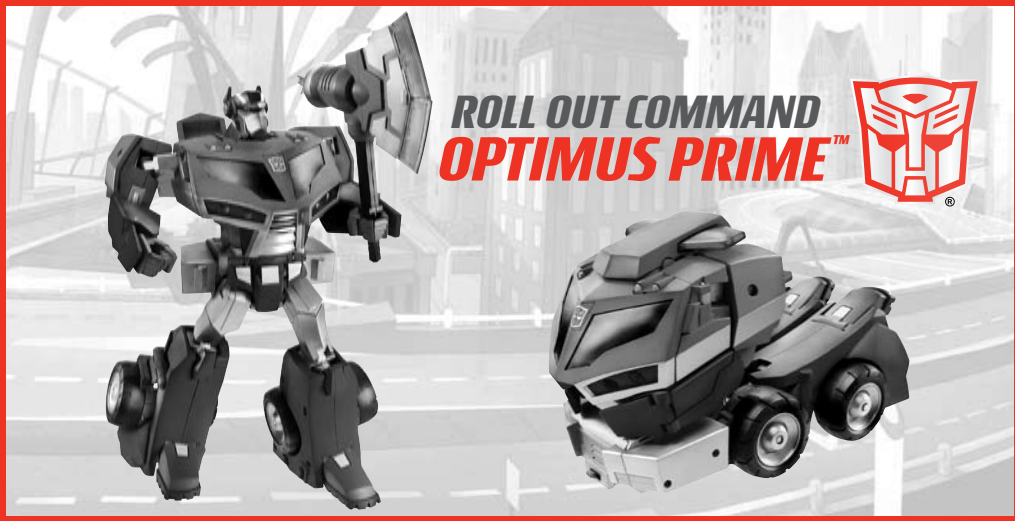

ROLL OUT COMMAND
OPTIMUS PRIME™



AGES 5+
89449/15213 Asst.

x2
1.5V AAA
R03 size
BATTERIES INCLUDED

Replace with 2 x 1.5V "AAA" or R03 size batteries. Alkaline batteries recommended. Phillips/cross head screwdriver (not included) needed to replace batteries.

NOTE: Some parts are made to detach if excessive force is applied and are designed to be reattached if separation occurs. Adult supervision may be necessary for younger children.

CHANGING TO VEHICLE

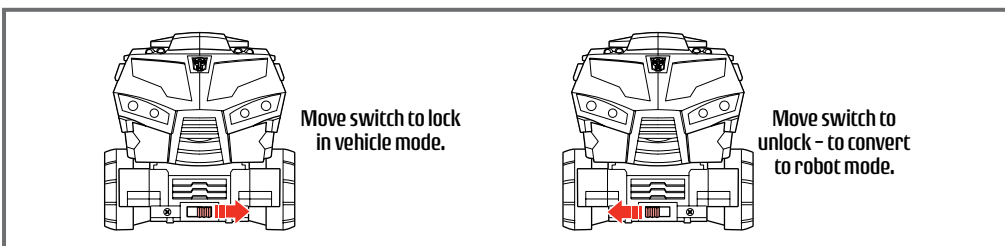
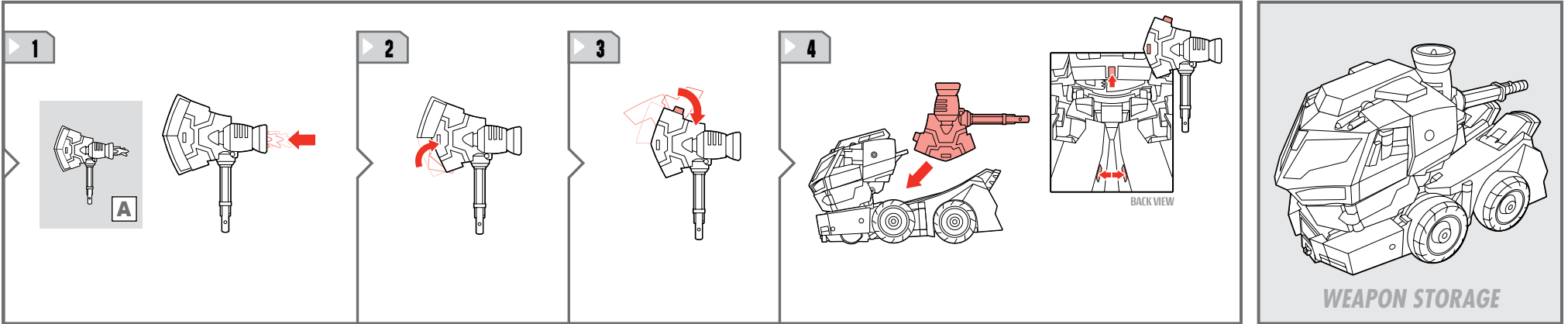
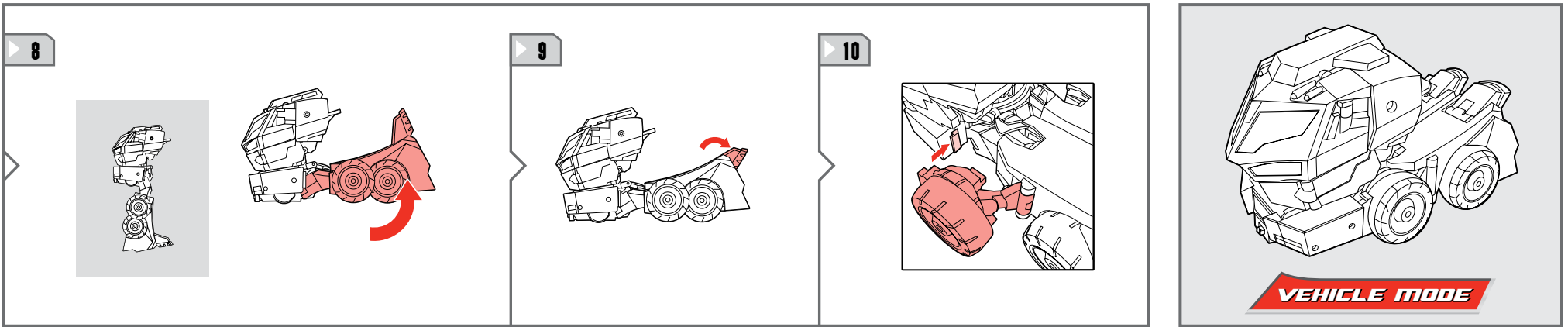
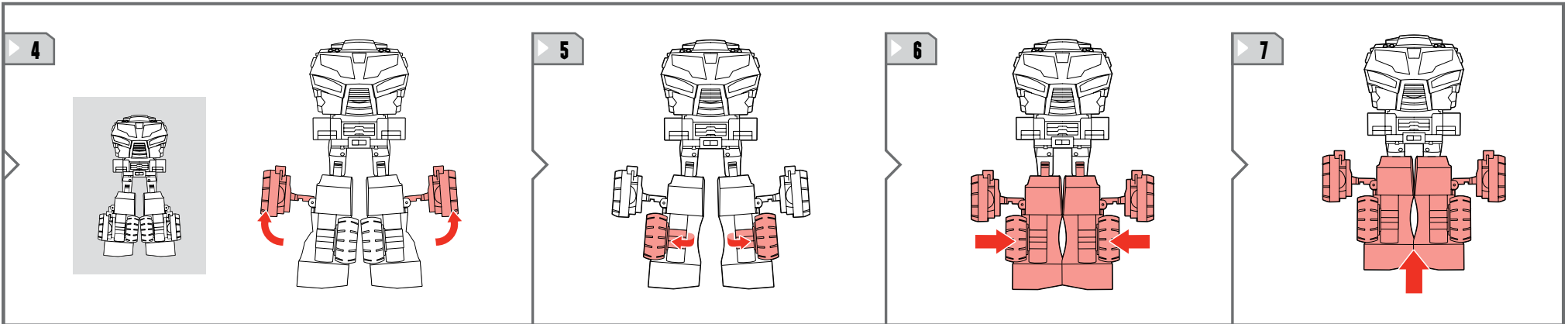
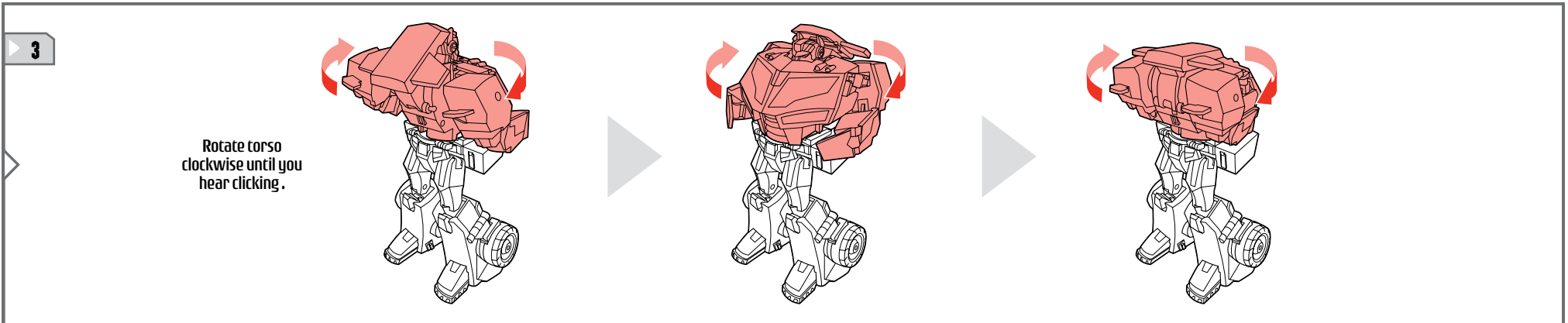
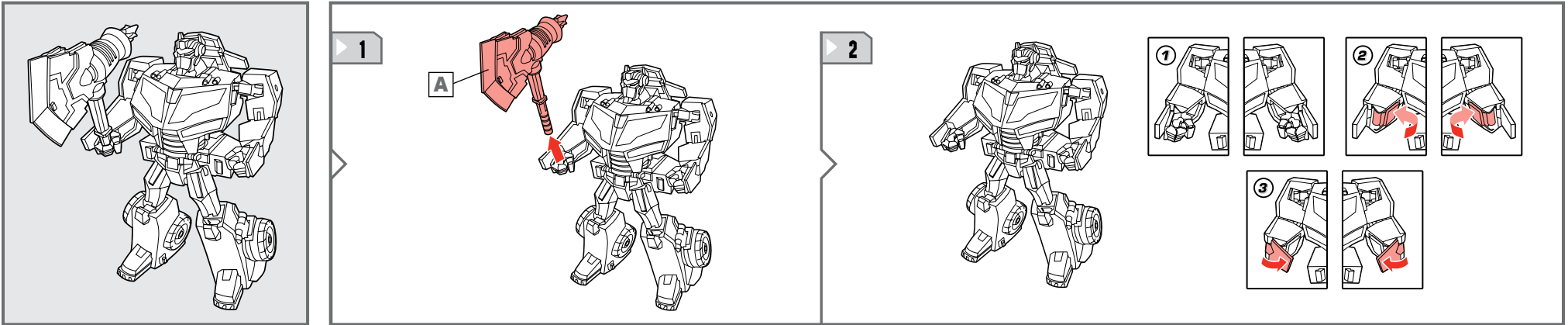

P/N 6835300000

TRANSFORMERS.COM



Some poses may require hand support.

© 2008 Hasbro. All Rights Reserved. TM & © denote U.S. Trademarks. Manufactured under license from Tomy Company, Ltd.



Not suitable for children under 3 years because of small parts - choking hazard.

CHANGING TO ROBOT

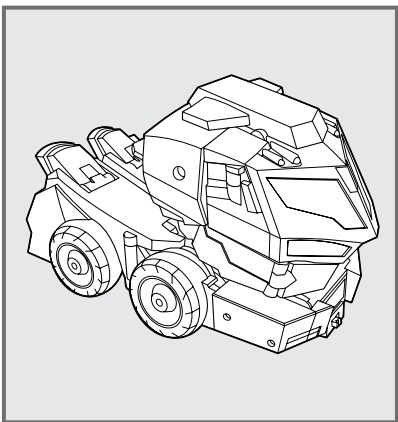

1

Place on wheels and roll forward about three feet.

Note: Switch must be moved to unlock position.

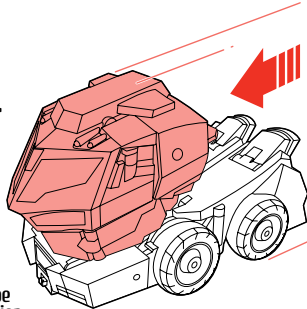

**AUTO-SPIN
CONVERSION**

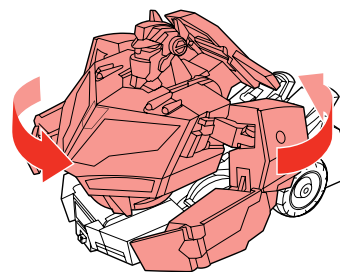
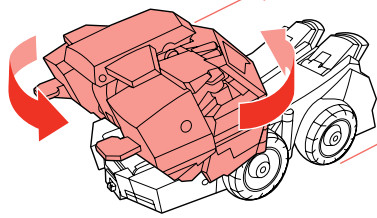

2

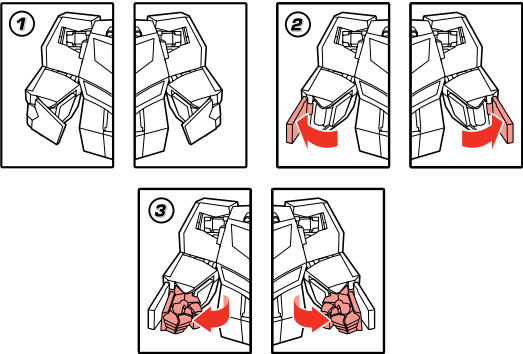
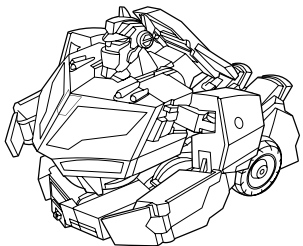

3

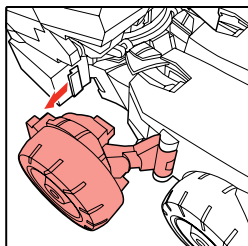

4

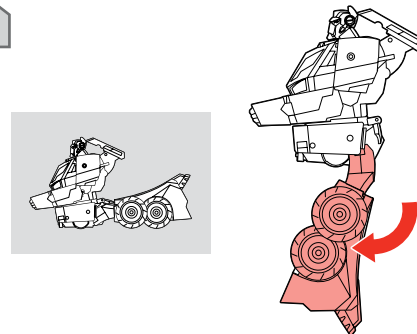

5

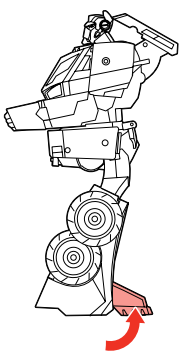

6

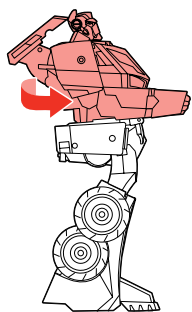

7

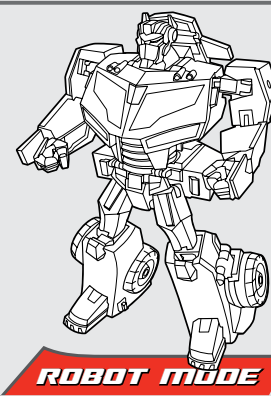
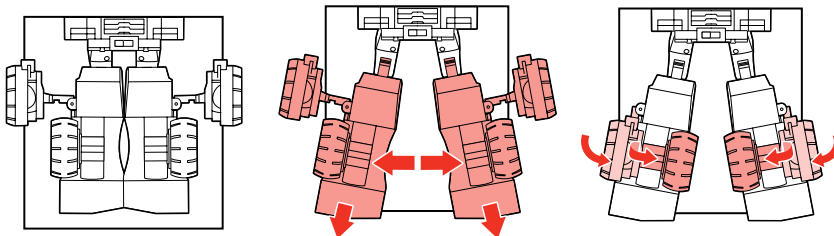

Press AUTOBOT symbol for speech and light-up eyes.

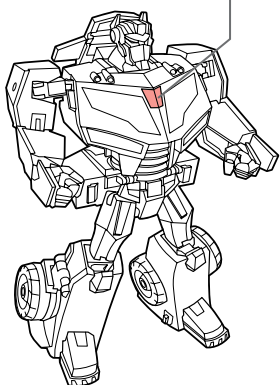

Press AUTOBOT symbol for revving engine, horn and lights.

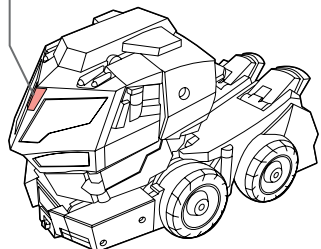

Place axe in hand. Push to pop out "plasma blade!"

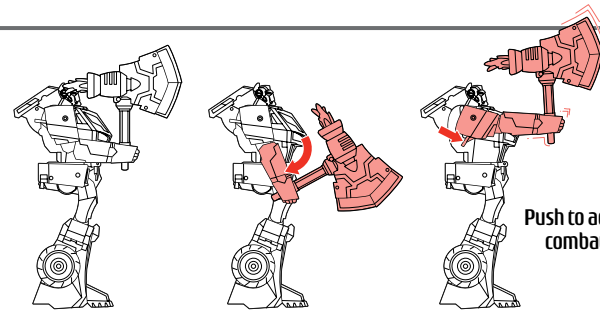
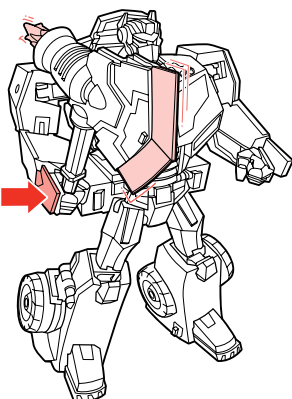

Push to activate axe combat action!

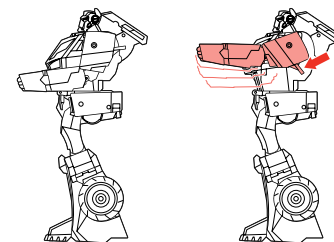

Push to activate punching action!

TO REPLACE BATTERIES:

Using a Phillips/cross head screwdriver, loosen screws in battery compartment door. Remove door. Remove and discard old batteries. Insert 2 x 1.5V "AAA" or R03 size batteries. Alkaline batteries recommended. Replace battery compartment door and tighten screws. See diagram for polarity.

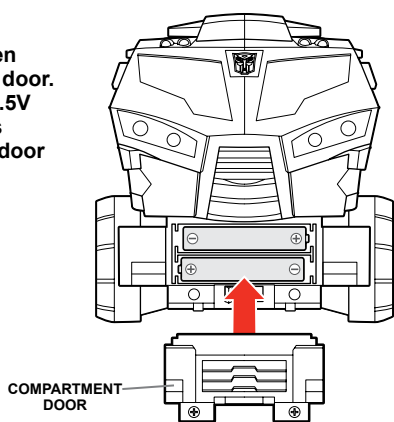

FCC STATEMENT

This device complies with part 15 of the FCC Rules. Operation is subject to the following two conditions: (1) This device may not cause harmful interference, and (2) this device must accept any interference received, including interference that may cause undesired operation. This equipment has been tested and found to comply with the limits for a Class B digital device, pursuant to part 15 of the FCC Rules. These limits are designed to provide reasonable protection against harmful interference in a residential installation. This equipment generates, uses and can radiate radio frequency energy, and, if not installed and used in accordance with the instructions, may cause harmful interference to radio communications. However, there is no guarantee that interference will not occur in a particular installation. If this equipment does cause harmful interference to radio or television reception, which can be determined by turning the equipment off and on, the user is encouraged to try to correct the interference by one or more of the following measures:

- Reorient or relocate the receiving antenna.
- Increase the separation between the equipment and receiver.
- Consult the dealer or an experienced radio/TV technician for help.

CAUTION: Changes or modifications not expressly approved by the party responsible for compliance could void the user's authority to operate the equipment.

CAUTION:

1. As with all small batteries, the batteries used with this toy should be kept away from small children who still put things in their mouths. If they are swallowed, promptly see a doctor and have the doctor phone (202) 625-3333 collect. In other countries, have the doctor call your local poison control center.
2. Make sure the batteries are inserted correctly and always follow the toy and battery manufacturer's instructions.
3. Do not mix old and new batteries, alkaline, standard (carbon-zinc) or rechargeable (nickel-cadmium) batteries.

IMPORTANT: BATTERY INFORMATION

Please retain this information for future reference. Batteries should be replaced by an adult.

CAUTION:

1. Always follow the instructions carefully. Use only batteries specified and be sure to insert them correctly by matching the + and - polarity markings.
2. Do not mix old batteries and new batteries, or standard (carbon-zinc) with alkaline batteries.
3. Remove exhausted or dead batteries from the product.
4. Remove batteries if product is not to be played with for a long time.
5. Do not short-circuit the supply terminals.
6. Should this product cause, or be affected by, local electrical interference, move it away from other electrical equipment. Reset (switching off and back on again or removing and reinserting batteries) if necessary.
7. RECHARGEABLE BATTERIES: Do not mix these with any other types of battery. Always remove from the product before recharging. Recharge batteries under adult supervision. DO NOT RECHARGE OTHER TYPES OF BATTERIES.
8. As with all small items, these batteries should be kept away from children. If swallowed, seek medical attention immediately.